

22260514	<b>DATA SHEET</b>	
Valid from: 21.12.2023	<b>AB-C3-M12Y-(L*)PUR-M8FS</b>	

## Product description

- Sensor/actuator cable, 3-pol, PUR halogen-free, black
- Straight Y-plug M12 on 2x straight M8-jack



## General characteristics

Number of pins	3
Ambient temperature	-25 °C to +90 °C (-13°F to 194°F) (plug / jack) -40 °C to +80 °C (-40°F to 176°F) (cable, fixed installation) -25 °C to +80 °C (-13°F to 176°F) (cable, movable installation)
Degree of protection	IP65 / IP67 / IP68
Coding	A-standard
Tightening torque	0,4 Nm (M12-connector) 0,2 Nm (M8-connector)

## Variation

Article number	Description	Length [m]	Configuration
22260514	AB-C3-M12Y-0,3PUR-M8FS	0,3	straight – straight, straight
22260515	AB-C3-M12Y-0,6PUR-M8FS	0,6	straight – straight, straight
22260516	AB-C3-M12Y-1,0PUR-M8FS	1,0	straight – straight, straight
22260517	AB-C3-M12Y-2,0PUR-M8FS	2,0	straight – straight, straight

## Additional note

Data sheet also valid for variant lengths. Other lengths on request.

## Electrical properties

Rated voltage	48 V AC / 60 V DC
Rated current	4 A
Overvoltage category	II
Pollution degree	3

## Mechanical properties

### Plug, jack

Inflammability class in accordance with UL 94	HB
Contact, material	CuSn
Contact carrier, material	TPU GF
Contact surface, material	Ni/Au
Knurl, material	Zinc diecasting, nickel-plated
Handle, material	TPU, flame retardant, self-extinguishing
Seal, material	NBR

Creator: THLE3/PDP Released: IVSE1/PDP	Document: DB22260514EN Version: 07	Page 1 of 3
---	---------------------------------------	-------------

22260514	<b>DATA SHEET</b>	
Valid from: 21.12.2023	<b>AB-C3-M12Y-(L*)PUR-M8FS</b>	

**Line**

Cable construction	3 x AWG24/32
Signal line, construction	32 x 0,1 mm
Conductor cross-section	0,25 mm <sup>2</sup>
Conductor diameter including isolation	1,17 mm ± 0,02 mm
Cable outer diameter	4,4 mm ± 0,15mm
Insulation color	brown, blue, black
Sheath color	grey-black, RAL 7021
Number of bending cycles	10.000.000
Bending radius	44 mm
Traveling distance	10 m
Traveling speed	3 m/s
Acceleration	10 m/s <sup>2</sup>
Cable weight	18 kg/km
Outer coating, material	PUR
Wire insulation, material	PP
Insulation resistance	≥ 100 GΩ*km (at 20 °C)
Conductor resistance	≤ 78 Ω/km (at 20 °C)
Flame resistance	acc. to UL 758 / 1581 FT2 DIN EN 60332-2-2 (20 s)
Halogen-free	acc. to DIN VDE 0472 Part 815
Oil resistance	acc. to DIN EN 60811-2-1
Other resistances	resistant to hydrolysis and microbes good resistant to acids, lyes and solvents limited UV resistance acc. to DIN EN ISO 4892-2-A resistant to sea water

**Standards**

Product standard, M12 connector	IEC 61076-2-101
UL-Listed, E-File	E249137

Creator: THLE3/PDP Released: IVSE1/PDP	Document: DB22260514EN Version: 07	Page 2 of 3
---	---------------------------------------	-------------

22260514	<b>DATA SHEET</b>	
Valid from: 21.12.2023	<b>AB-C3-M12Y-(L*)PUR-M8FS</b>	

**Technical drawing**

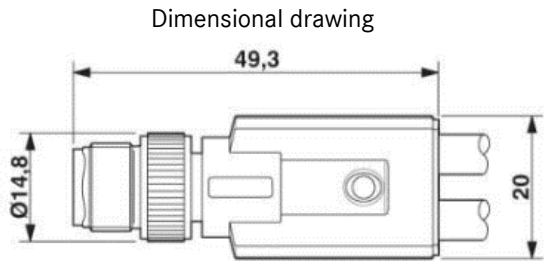

Plug Y, M12 x 1, straight

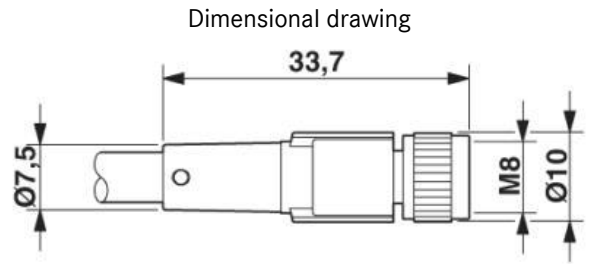

Jack M8 x 1, straight

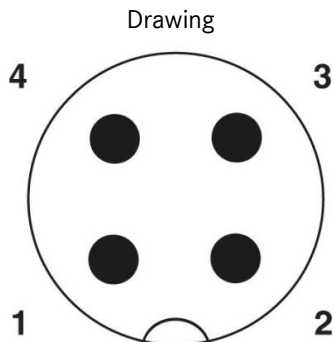

Pin assignment M12-plug Y, 4-pol, A-coding

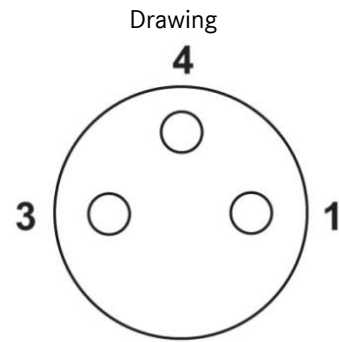

Pin assignment M8-jack, 3-pol, A-coding

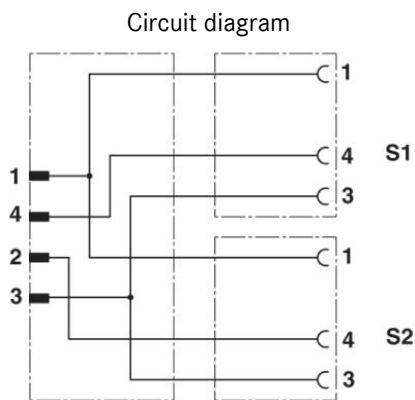

Pin assignment between M12-plug Y and M8-jack

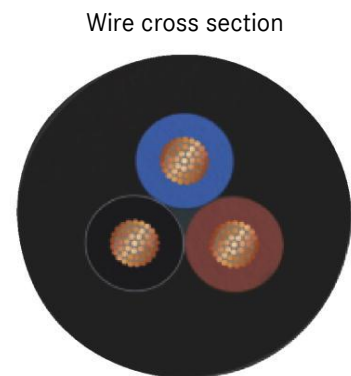

**Application range**

For increased mechanical load and rough operating conditions

**Note**

Photographs are not true to scale and do not represent detailed images of the respective products.

Creator: THLE3/PDP Released: IVSE1/PDP	Document: DB22260514EN Version: 07	Page 3 of 3
---	---------------------------------------	-------------